



Superior manufactures attractive gates with custom locks upon request. Series 900 Railing on brick retaining wall.



The balcony is supported by Superior Fiberglass Columns.

Also available are cast aluminum X-inserts that can be mounted in Superior Series 900 Railing.



The balcony railing shown on roof top is Series 990 with Superior panel column posts. The railing shown in foreground is Series 900.

MATERIALS - (For Series 900, 950, and 990) All rails, posts and pickets shall be formed from 6063-T6 extruded aluminum alloys. All railing accessories shall be cast from ANSI 713 alloy. All exposed fasteners used in the system shall be aluminum or stainless steel.

INSTALLATION - (For Series 900 and 950) The railing system shall consist of 2" or 2-1/2" square posts that can be either base mounted, side mounted or embedded into concrete. The top rail shall be 2" or 2-1/2" wide and the bottom rail a minimum of 1-5/8" wide. Pickets shall be 3/4" square on 4-1/2" or 6" centers, and shall run between the top and bottom rail.

The top rail shall be continuous in lengths up to 24'. The railing system will adapt to step railing requirements by specifying a rectangular hole in bottom rail.

INSTALLATION - (For Series 990) The railing system shall consist of 2-1/2" square posts that can be either base mounted, side mounted or embedded into concrete. The top rail shall be 2" or 2-1/2" wide and the bottom rail a minimum of 1-5/8" wide. Pickets shall be 1-1/2" x 3/4" on 5-1/4" or 6" centers, and shall run between the top and bottom rail. The top rail shall be continuous in lengths up to 24'. The railing system can meet step railing

requirements by specifying the riser and tread dimensions of the steps.

SCOPE OF WORK - Aluminum railings as shown on drawings shall be Superior Series 900 Heavy-Duty Aluminum Railings

Series 900 railing meets federal safety requirements as determined by an independent testing laboratory. Test results available upon request. Superior Series 900 railing is protected by U S Patent #3707276.

Ask about our complete line of other...

Superior Aluminum Products:

- Round and All-Snap Fluted Aluminum Columns
- Square Fluted, Panel and Smooth Aluminum Columns
- Fiberglass Columns - Round & Square
- Series 500 Non-Welded Aluminum Pipe Railing
- Series 550 Non-Welded Aluminum Pipe Picket Railing
- Series 600 Custom Residential Railing & Columns
- Series 700 Aluminum Picket Fence & Custom Gates
- Series 800 Quick-Lock Aluminum Pipe Rail
- Spun Aluminum Flagpoles and Flags



Superior Round Aluminum Columns



Superior Non-Welded Pipe Picket Railing



Superior Series 700 Aluminum Picket Fence & Custom Gates

Aluminum Railing

SERIES 900

Strong, Durable and Maintenance-Free Beauty!

Meets OSHA, ADA and ICC Safety Criteria



Strong, Durable, and Maintenance-Free Beauty!

Heavy-Duty Aluminum Railing

**SERIES
900
950
990**

Product Presentation

Superior Series 900, 950, and 990 Heavy Duty Aluminum Railings offer the finest railing design features available on the market today. The highest quality aluminum alloy extrusions are used to provide maximum strength and support where it is needed most - in your installation.

All Superior Series 900 Railings utilize the advantages of aluminum - strong, durable, rust and corrosion free. These characteristics make aluminum railings a practical, sound investment for the budget minded builder. The smart, contemporary design of Superior railing is an added plus. No complicated fittings. No costly custom - made fabrication. Just the minimum of

fasteners make Superior railings easy to install.

Superior Series 900 Railings are available in heights from 32" to 48". Optional pool railing is available in heights up to 72". Factory assembled railings are made to your exact specifications resulting in further site fabrication savings.

Series 900 Railings can be found wherever clean design and safety are a must. Great for condominiums, apartments, motels, churches, schools, commercial buildings and homes.

To make Series 900 even more versatile, decorative flat columns, inserts and scrolls are available.

Finishes

Smart, decorative finishes add a distinctive touch to any building. Whether baked-on enamel, anodized or duranodic, these finishes are guaranteed to endure for years of continued service and maintenance-free beauty.



SERIES 900

The Superior Series 900 design features a 3/4" square picket and a 2-1/2" square post. The standard top rail is 2-1/2" wide x 1-5/8", but a 2" x 4" high top rail is also available.



SERIES 950

The Superior Series 950 design meets ADA Regulations, requiring a 2" wide maximum width for the top hand rail. Pickets are 3/4" square and posts are 2" square.



SERIES 990

The Superior Series 990 design simulates wood, but has the no-maintenance qualities of aluminum. It features 1-1/2" wide x 3/4" pickets and 2-1/2" square posts. The standard top rail is 2" wide x 4" high, but 2" or 2-1/2" wide x 1-5/8" high top rails are also available.

The Series 900, 950, and 990 meet OSHA and ICC Safety Criteria.

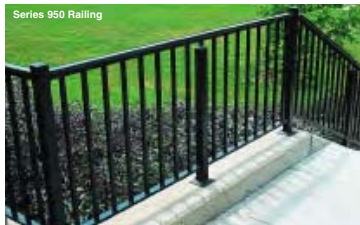

Railing Style Systems Superior Aluminum offers various styles to fit almost any application in Series 900, 950 and 990 Railing.

Style A

Standard Top Rail System:

Available top rail size options - 2" wide x 1-5/8" high, 2-1/2" wide x 1-5/8" high, or 2" wide x 4" high.



Style B

Double Top Rail System:

Available top rail size options - 2" wide x 1-5/8" high, 2-1/2" wide x 1-5/8" high, or 2" wide x 4" high.



Style C

4" Square Post System:

Available top rail size options - 2-1/2" wide x 1-5/8" high, or 2" wide x 4" high.



Style D

Hand Rail System: (with mtg. brackets)

Available hand rail size options: 2" wide x 1-5/8" high, 2-1/2" wide x 1-5/8" high, or 2" wide x 4" high. Superior Series 500 Pipe Rail (not shown) is also available.



SERIES 900

Well-crafted lines

The well-crafted clean lines of Superior Series 900 railing fits almost any commercial or residential building application. It's beauty, strength and durability will compliment your construction ideas.

900
950
990



Assembly Identification

- #990 2-1/2" Tube .075" Wall
- 957 Base Assembly
- 950 Cap
- 956 Bottom Rail Swivel Assem.
- 955 Top Rail Swivel Assem.
- 940 Top & Bottom Rigid Attachment
- 901 Top Rail 2-1/2" W. x 1-5/8" H.
- 905 Top Rail 2" W. x 1-5/8" H.
- 903 Bottom Rail
- 904 Bottom Rail (A)
- 3/4" Sq. Picket
- Crossover Post
- #912 8-32 Binder Bolt
- #910 Picket Screws
- #915 5/32" Dia. Rivets
- 902 Top Rail 2" W. x 4" H.

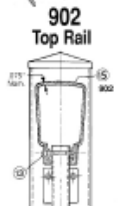
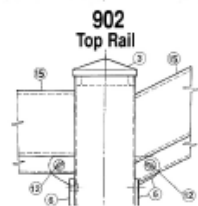
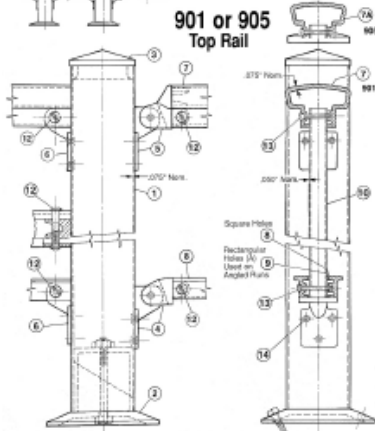
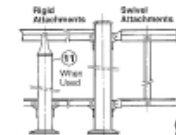

Design Selections

Straight Rails 900, 950 or 990

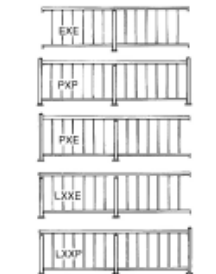

Step Rails 900, 950 or 990

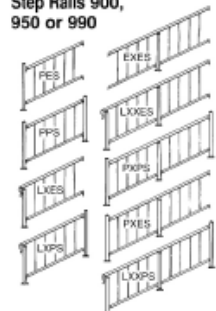

Hand Rail System



Component Parts

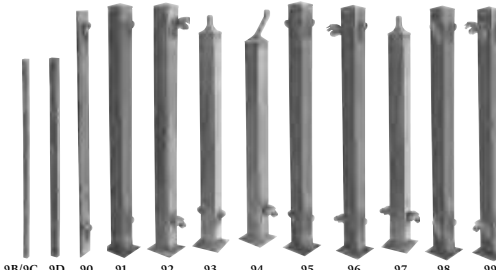
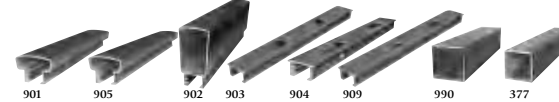

Parts Description

RAILS

- 901 Top Rail 2-1/2" W. x 1-5/8" H.
- 902 Top Rail 2" W. x 4" H.
- 903 Bottom Rail (Sq. Hole) 1-5/8" W. x 3/4" H., 16' & 18' Lgths.
- 904 Bottom Rail (Rect. Hole) 1-5/8" W. x 3/4" H., 16' & 18' Lgths.
- 905 Top Rail - 2" W. x 1-5/8" H. 18' & 24' Lgth.
- 909 Bottom Rail (1-1/2" W. Hole) 16' & 18' Lgths.
- 940 End Brkt. for #903 Bottom Rail
- 941 17" Cast "Fleur De-Lis" Insert
- 942 Cap for 2" Post
- 943 Post Ball Cap for 4" Post with 2-1/2" Diameter Ball
- 946 Adj. End Brkt Top (for 902)
- 947T Adj. End Fitting Top (for 901)
- 947B Adj. End Fitting Bottom
- 949 End Bracket for #902
- 950 Cap for 2-1/2" Post
- 951 Post Ball Cap for 2-1/2" Post
- 952 Top Rail Hinge 2-1/2" W.
- 953T 2-Way Swivel Bracket - 2-1/2" Cap for 2-1/2" Post
- 954T Horiz. Swivel Brkt. Top - 2-1/2"
- 954B Horiz. Swivel Brkt. Bottom
- 955 Vertical Swivel Top 2-1/2" W.
- 956 Vertical Swivel Bottom
- 957 Base for 2-1/2" Post (wedge type)
- 958 Angle Ramp Plate
- 959 Vertical Swivel Top 2" W.
- 960 Crossover Cap for 2-1/2" Post
- 961 Cap for 2" Post
- 962 Top Rail Hinge 2" W.
- 963 Top Rail Corner 2" W.
- 964 Top Rail Corner 2-1/2" W.
- 965 Crossover Cap for 2-1/2" Post
- 966 Crossover Cap for 2-1/2" Post (Flat)
- 967 Crossover Cap for 1-1/2" Sq. Tube Base for 2" Post (Wedge Type)
- 969T Horiz. Swivel Brkt. Top - 2" W.
- 970 Angle Crossover Cap for 2-1/2" Step Post
- 971 Cap for 2-1/2" Post (Heavy Wall)
- 972 Crossover Cap for 2-1/2" Post (Heavy Wall)
- 973 Heavy Duty Base for 2-1/2" Post
- 974 2-1/2" Sq. 42" - 5/16" w/#973 Welded On
- 975 Side Mount Brkt. for 2-1/2" Post
- 976 Corner Side Mount Brkt for 2-1/2" Post
- 977 Side Mount Bracket for 2" Post
- 978L Wall Return - LH for #905 Top Rail
- 978R Wall Return - RH for #905 Top Rail
- 979 End Cap for #905 Top Rail
- 980 End Cap for #901 Top Rail
- 981 End Cap for Bottom Rail
- 982 End Cap for #902 Top Rail
- 983 Lambs Tongue for #901 Top Rail
- 984 Horizontal Swivel for #902
- 985 Wall Brkt. for Handrail 3"
- 986 Lambs Tongue for #905 Top Rail
- 988 90° Double Swivel for #905 Top Rail
- 989 Post Ball Cap for 2" Post
- 992 Post Finial for 2-1/2" Post
- 993 Cast Rose Snap-on Picket Insert
- 994 Cast Grape Snap-on Picket Insert
- 995 Cast Oak Snap on Picket Insert
- 997 Cast "X" Insert (4" Opening)
- 998 Corner Side Mount Bracket for 2" Post

FASTENERS

- 910 Picket Screws
- 912 Rail Bracket Binder Bolt
- 915 Post Brkt. Rivet 5/32"

POSTS & PICKETS

- 9B — Picket 3/4" Sq. 4-1/2" Centers
- 9C — Picket 3/4" Sq. 6" Centers
- 9D — Picket 3/4" x 1-1/2"
- 964 Top Rail Corner 2-1/2" W.
- 965 Crossover Cap for 2-1/2" Post
- 966 Crossover Cap for 2-1/2" Post (Flat)
- 967 Crossover Cap for 1-1/2" Sq. Tube Base for 2" Post (Wedge Type)
- 969T Horiz. Swivel Brkt. Top - 2" W.
- 970 Angle Crossover Cap for 2-1/2" Step Post
- 971 Cap for 2-1/2" Post (Heavy Wall)
- 972 Crossover Cap for 2-1/2" Post (Heavy Wall)
- 973 Heavy Duty Base for 2-1/2" Post
- 974 2-1/2" Sq. 42" - 5/16" w/#973 Welded On
- 975 Side Mount Brkt. for 2-1/2" Post
- 976 Corner Side Mount Brkt for 2-1/2" Post
- 977 Side Mount Bracket for 2" Post
- 978L Wall Return - LH for #905 Top Rail
- 978R Wall Return - RH for #905 Top Rail
- 979 End Cap for #905 Top Rail
- 980 End Cap for #901 Top Rail
- 981 End Cap for Bottom Rail
- 982 End Cap for #902 Top Rail
- 983 Lambs Tongue for #901 Top Rail
- 984 Horizontal Swivel for #902
- 985 Wall Brkt. for Handrail 3"
- 986 Lambs Tongue for #905 Top Rail
- 988 90° Double Swivel for #905 Top Rail
- 989 Post Ball Cap for 2" Post
- 992 Post Finial for 2-1/2" Post
- 993 Cast Rose Snap-on Picket Insert
- 994 Cast Grape Snap-on Picket Insert
- 995 Cast Oak Snap on Picket Insert
- 997 Cast "X" Insert (4" Opening)
- 998 Corner Side Mount Bracket for 2" Post

CAST FITTINGS

- 722 Base for 2" or 2-1/2" Post
- 730 Cap for 4" Post
- 906 17" Heart Scroll
- 913 Internal splice for #905 Top Rail
- 914 Post Ball Cap for 4" Post with 4" Diameter Ball
- 916 2 1/2" Wedge Base /w Stud
- 917 Wedge Base for 4" Post
- 918 Wedge Base for 2" Post
- 919 2" Slip Over Base
- 920 2-1/2" Slip Over Base
- 921 3/4" Square Base
- 922 3/4" x 1-1/2" Base
- 929 Cast "X" Insert (4" Opening)
- 933T 2-Way Swivel Bracket - 2"
- 935 3-3/4" OD Double Ring
- 936 Hanging Rail "L" Brackets
- 937 3-3/4" Cast Diamond
- 938 Angle Crossover Cap for 2" Step Post
- 939T Adj. End Fitting (for 905)
- 940 End Brkt. for Top & Bottom Rail
- 941 17" Cast "Fleur De-Lis" Insert
- 942 Cap for 2" Post
- 943 Post Ball Cap for 4" Post with 2-1/2" Diameter Ball
- 946 Adj. End Brkt Top (for 902)
- 947T Adj. End Fitting Top (for 901)
- 947B Adj. End Fitting Bottom
- 949 End Bracket for #902
- 950 Cap for 2-1/2" Post
- 951 Post Ball Cap for 2-1/2" Post
- 952 Top Rail Hinge 2-1/2" W.
- 953T 2-Way Swivel Bracket - 2-1/2" Cap for 2-1/2" Post
- 954T Horiz. Swivel Brkt. Top - 2-1/2"
- 954B Horiz. Swivel Brkt. Bottom
- 955 Vertical Swivel Top 2-1/2" W.
- 956 Vertical Swivel Bottom
- 957 Base for 2-1/2" Post (wedge type)
- 958 Angle Ramp Plate
- 959 Vertical Swivel Top 2" W.
- 960 Crossover Cap for 2-1/2" Post
- 961 Cap for 2" Post
- 962 Top Rail Hinge 2" W.
- 963 Top Rail Corner 2" W.
- 964 Top Rail Corner 2-1/2" W.
- 965 Crossover Cap for 2-1/2" Post
- 966 Crossover Cap for 2-1/2" Post (Flat)
- 967 Crossover Cap for 1-1/2" Sq. Tube Base for 2" Post (Wedge Type)
- 969T Horiz. Swivel Brkt. Top - 2" W.
- 970 Angle Crossover Cap for 2-1/2" Step Post
- 971 Cap for 2-1/2" Post (Heavy Wall)
- 972 Crossover Cap for 2-1/2" Post (Heavy Wall)
- 973 Heavy Duty Base for 2-1/2" Post
- 974 2-1/2" Sq. 42" - 5/16" w/#973 Welded On
- 975 Side Mount Brkt. for 2-1/2" Post
- 976 Corner Side Mount Brkt for 2-1/2" Post
- 977 Side Mount Bracket for 2" Post
- 978L Wall Return - LH for #905 Top Rail
- 978R Wall Return - RH for #905 Top Rail
- 979 End Cap for #905 Top Rail
- 980 End Cap for #901 Top Rail
- 981 End Cap for Bottom Rail
- 982 End Cap for #902 Top Rail
- 983 Lambs Tongue for #901 Top Rail
- 984 Horizontal Swivel for #902
- 985 Wall Brkt. for Handrail 3"
- 986 Lambs Tongue for #905 Top Rail
- 988 90° Double Swivel for #905 Top Rail
- 989 Post Ball Cap for 2" Post
- 992 Post Finial for 2-1/2" Post
- 993 Cast Rose Snap-on Picket Insert
- 994 Cast Grape Snap-on Picket Insert
- 995 Cast Oak Snap on Picket Insert
- 997 Cast "X" Insert (4" Opening)
- 998 Corner Side Mount Bracket for 2" Post

TUBING

- 990 2-1/2" Sq. - 16' & 18' Lgths.
- 996 2 1/2" Sq - 18' Length (3/16" Wall)
- 377 2" Sq. - 16' Length
- 380 4" Sq. - 16' Length



SERIES 950

Meets ADA regulations

Superior Series 950 Aluminum Railing was developed to meet state, local and federal codes requiring ADA Regulations and Guidelines. The narrowed 2" maximum top rail on the series 950 allows for a normal grip on ramps, stairs, or on horizontal railing and still maintains a pleasing and aesthetic look. The Series 950 Railing is used on office buildings, commercial applications, hospitals, industrial and educational environments, as well as apartments and homes.



905 Top Rail with Superior Aluminum Panel Columns

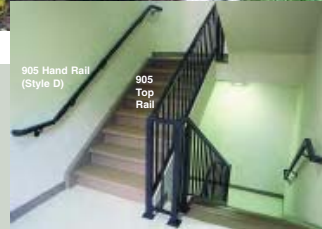

905 Hand Rail (Style D)

905 Top Rail



905 Top Rail



905 Top Rail with Superior Aluminum Square Columns.



905 Top Rail with Superior Aluminum Square Smooth Columns.



905 Top Rail. In this application separate 905 Hand Rails are provided (Style D).

SERIES 990

The look of wood

Superior Series 990 Aluminum Railing rivals the look of painted wood, but has the no-maintenance qualities of aluminum. Best of all it won't split, warp, or rot due to rain, ice, sunshine, or other outside elements. The Series 990 Railing, with its smooth, rugged and functional design, has depth and detail that has instant curb appeal.



902 Top Rail with 4" Post, (Style C).



901 Top Rail with Superior Aluminum Panel Columns



902 Top Rail



902 Top Rail



Custom Gate



902 Top Rail



902 Top Rail